

GENERAL BODY MOUNT ASSEMBLY INSTRUCTIONS

- 1) NOTE ALL BODY MOUNT POSITIONS AND RESPECTIVE PARTS (MOUNT SIZE/TYPE, WASHERS, SPACERS, BOLTS, SHIMS, ETC.) BEFORE AND DURING DISASSEMBLY. YOU MAY HAVE TO REUSE CERTAIN FACTORY HARDWARE PIECES THAT ARE NOT INCLUDED IN KIT.
- 2) IF MOUNTING BOLTS AND NUTS ARE RUSTED, LIBERALLY SPRAY WITH PENETRATING OIL IE. WD-40.
- 3) SUPPORT VEHICLE BODY PROPERLY BEFORE REMOVING MOUNTS. USE A 2"X4" PIECE OF WOOD 24" LONG (OR ANY OTHER SUITABLE SIZE) BETWEEN JACK AND BODY PANEL TO SPREAD THE WEIGHT LOAD OUT SO AS NOT TO DAMAGE THE BODY PANELS. IF NECESSARY, SUPPORT BODY IN SEVERAL AREAS.
- 4) LOOSEN ALL BOLTS AND NUTS BUT DO NOT REMOVE. (SEE SPECIAL DISASSEMBLY DIAGRAM FOR FORD ONLY).
- 5) WORKING FROM ONLY ONE SIDE OF VEHICLE AT A TIME REMOVE MOUNTING BOLT AND NUT AND RAISE BODY ONLY HIGH ENOUGH TO REPLACE MOUNT, NEVER HIGHER. ALSO CHECK OTHER AREAS ON BODY AND FRAME TO AVOID ANY INTERFERENCE PROBLEMS WHEN RAISING BODY.
- 6) REPLACE MOUNTS ONE AT A TIME. IF NECESSARY, A DIAGRAM HAS BEEN PROVIDED FOR INFORMATION AS TO WHICH MOUNTS, WASHERS, SLEEVES AND BOLTS TO USE FOR EACH POSITION. INSTALL BOLTS BUT DO NOT TIGHTEN UNTIL ALL MOUNTS HAVE BEEN REPLACED.
- 7) AFTER ALL MOUNTS HAVE BEEN REPLACED ,TORQUE BOLTS TO FACTORY SPECIFICATIONS.
- 8) AFTER DRIVING VEHICLE FOR ABOUT 1000 MILES OR OFF ROADING RE-TORQUE BOLTS AGAIN. THIS IS TO INSURE THAT THE BOLTS HAVE NOT LOOSENED DUE TO INITIAL SETTLING THAT MAY TAKE PLACE.

FORD BODY MOUNT DISASSEMBLY INSTRUCTIONS

MOST FORDS USE A UNIQUE ONE PIECE STAMPED WASHER AND SLEEVE ASSEMBLY. THIS TYPE OF ASSEMBLY CAN SOMETIMES BE DIFFICULT TO REMOVE ESPECIALLY ON OLDER VEHICLES. USE THIS DIAGRAM AND INSTRUCTIONS TO FACILITATE DISASSEMBLY.

- 1) REMOVE BODY MOUNT BOLT FROM INSIDE OF CAB.
- 2) THREAD A BOLT FROM BELOW INTO BOTTOM NUT/WASHER ASSEMBLY UNTIL BOLT IS FLUSH WITH INSIDE OF WASHER. THIS IS TO PROTECT THE THREADS OF NUT DURING REMOVAL.
- 3) INSERT PUNCH INTO BODY MOUNT ASSEMBLY FROM INSIDE CAB. DRIVE BOTTOM WASHER/SLEEVE ASSEMBLY DOWNWARD AWAY FROM TOP ASSEMBLY.
- 4) LIP ON SLEEVE OF BOTTOM STAMPED WASHER/SLEEVE ASSEMBLY MAY HAVE BECOME MUSHROOMED ESPECIALLY ON OLDER VEHICLES. BEFORE REINSTALLING THIS PART REMOVE MUSHROOMED LIP TO AVOID ANY INTERFERENCE FIT PROBLEMS.

PARTS ASSEMBLY LIST FOR 6-105

MOUNTING POSITIONS ARE NUMBERED STARTING WITH #1 FOR THE MOST FORWARD POSITION TOWARD THE FRONT OF THE VEHICLE AND RESPECTIVELY HIGHER NUMBERS TOWARD THE REAR OF THE VEHICLE.

PARTS ARE LISTED FROM TOP (#1) TO BOTTOM.

#1 MOUNT

- 1) UPPER MOUNT #60337
- 2) LOWER MOUNT #60339

#2 MOUNT

- 1) UPPER MOUNT #68022
- 2) LOWER MOUNT #68020

#3 MOUNT

- 1) UPPER MOUNT #60336
- 2) LOWER MOUNT #68021

PARTS LIST FOR KIT # 6-105

NUMBER	DESCRIPTION	QTY
U-60336	BODY MOUNT	2
U-60337	BODY MOUNT	2
U-60339	BODY MOUNT	2
U-68020	BODY MOUNT	2
U-68021	BODY MOUNT	2
U-68022	BODY MOUNT	2

FORD TYPE BODY MOUNT (Disassembly Diagram)

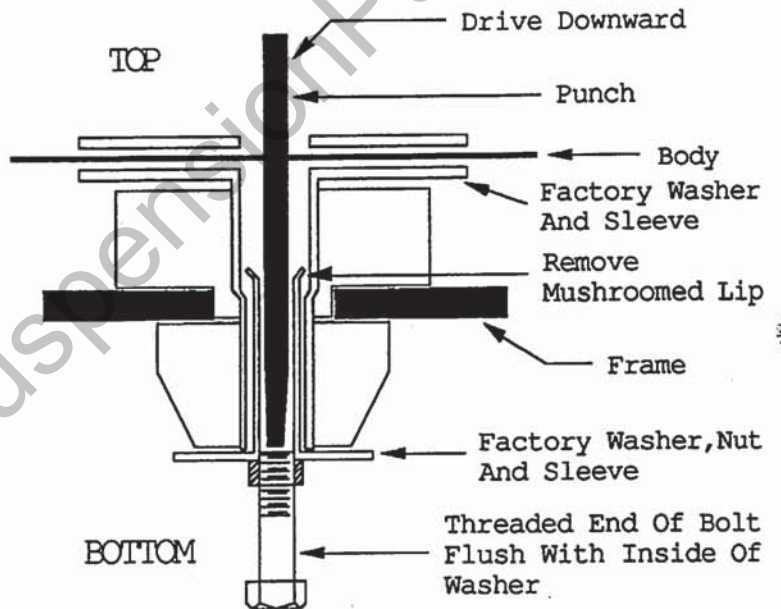

FORD TYPE BODY MOUNT (Assembly Diagram)

